

Retro Antenna

Installation Guide

Step #6 Assemble the Antenna Mast

Assemble the Antenna Mast by threading the Antenna Adapter into the bottom of the Antenna Mast. The fine threads go into the mast. Then thread the Nut onto the end of the Antenna Adapter. DO NOT OVERTIGHTEN.

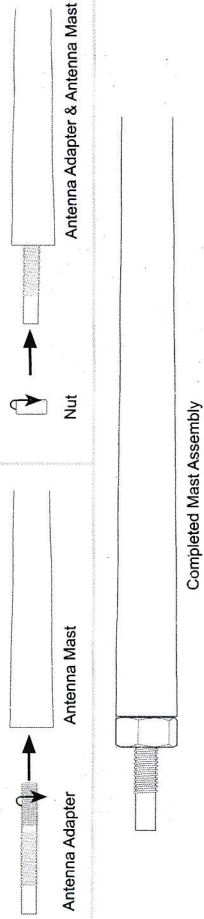

Step #7 Complete the Installation

Complete the installation by threading the Antenna Mast assembly into the Antenna Base.

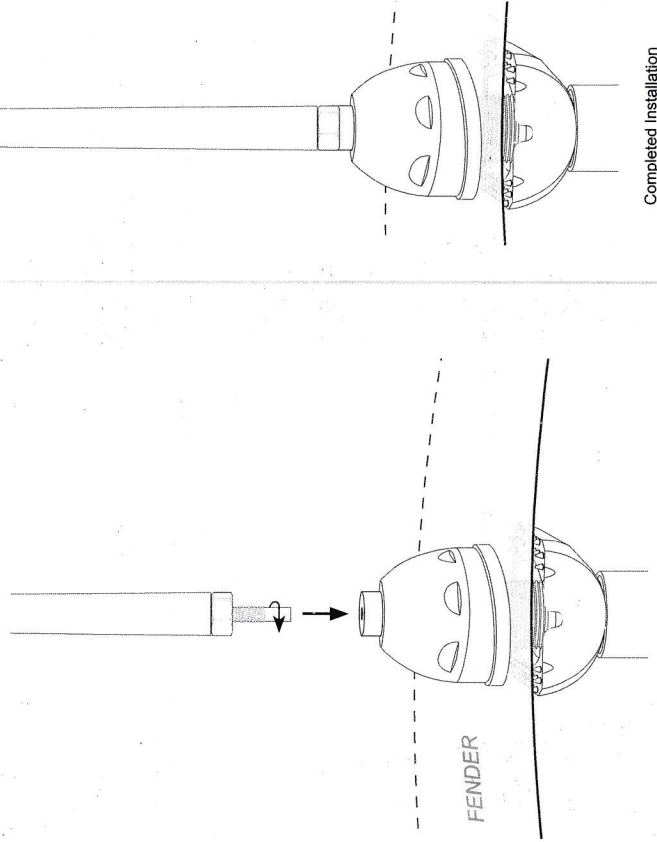

Retro
MANUFACTURING

7470 Commercial Way,
Henderson, NV 89011

Parts List (parts will vary depending on product purchased)

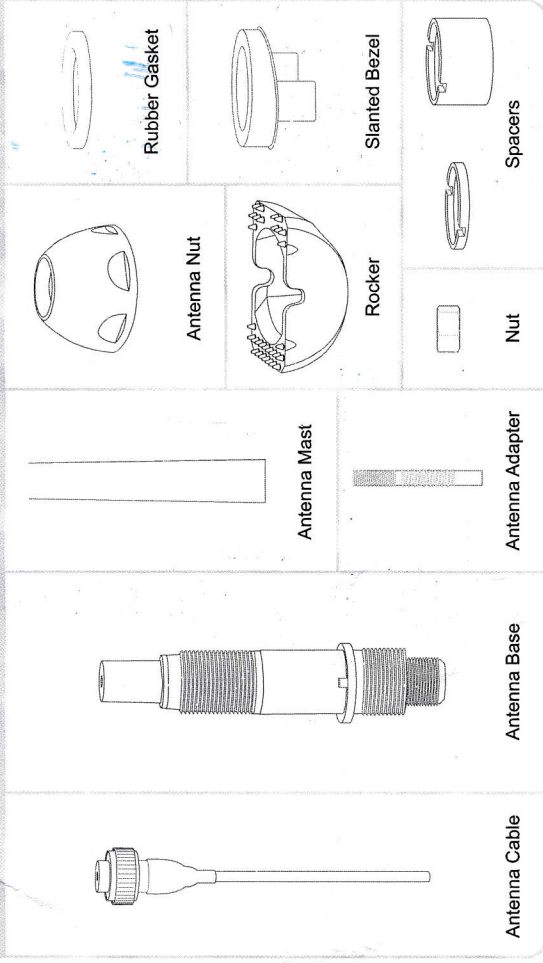

Step #1 Connect Antenna Cable to Antenna Base

Connect the Antenna Cable to the Antenna Base by threading the cable onto the bottom of the Antenna Base.

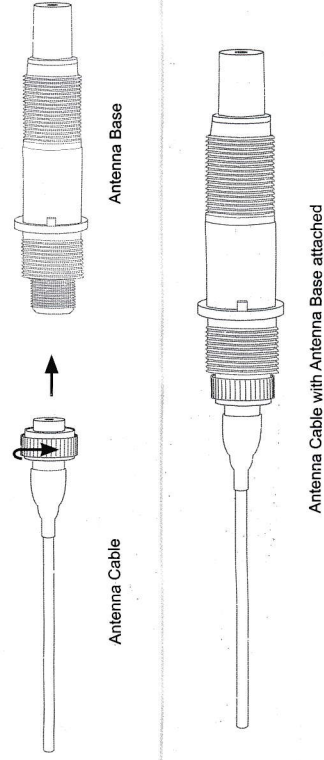

Step #2 Add the Spacer on the Antenna Base

Place one of the two Spacers on the Antenna Base by lining up the notches on the Spacer with the Antenna Base.

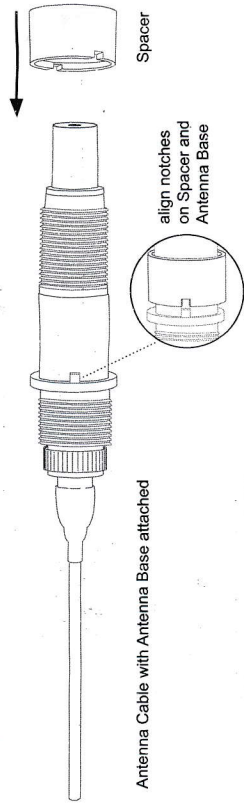

Step #3 Add the Rocker

Place the Rocker onto the Spacer with the rounded side down. (this allows the Antenna Base to match the angle of the Slanted Bezel)

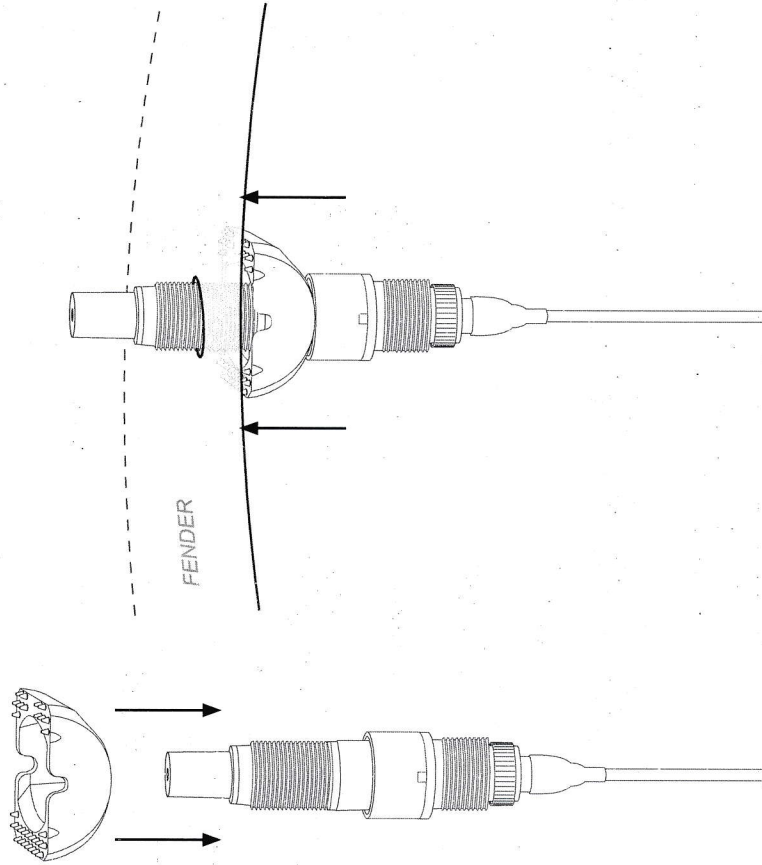

Place the antenna assembly through the opening on the fender.

Step #4 Add the Rubber Gasket and Slanted Bezel

With the antenna assembly placed through the fender, add the Rubber Gasket and then the Slanted Bezel.

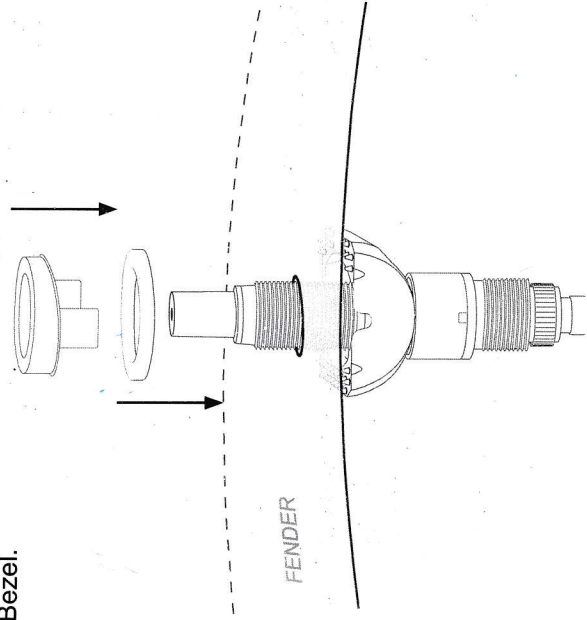

Step #5 Add the Antenna Nut

Add the Antenna Nut onto the top of the antenna assembly. DO NOT OVERTIGHTEN.

