

E4-WM5-Y217A00 EINBAUANLEITUNG/ MOUNTING INSTRUCTION



ALLE DARSTELLUNGEN SIND SCHEMATISCH!
KEINE DARSTELLUNG DIVERSER
HALTER O. Ä. AM FEDERBEIN!

ALL DRAWINGS ARE GENERALIZED!
BRACKETS, ETC. SPECIFIC TO
STRUT ARE NOT SHOWN!

STOSSDÄMPFERTYPEN/ TYPES OF SHOCK ABSORBER

• siehe Typenliste S. 1/ see application guide side 1

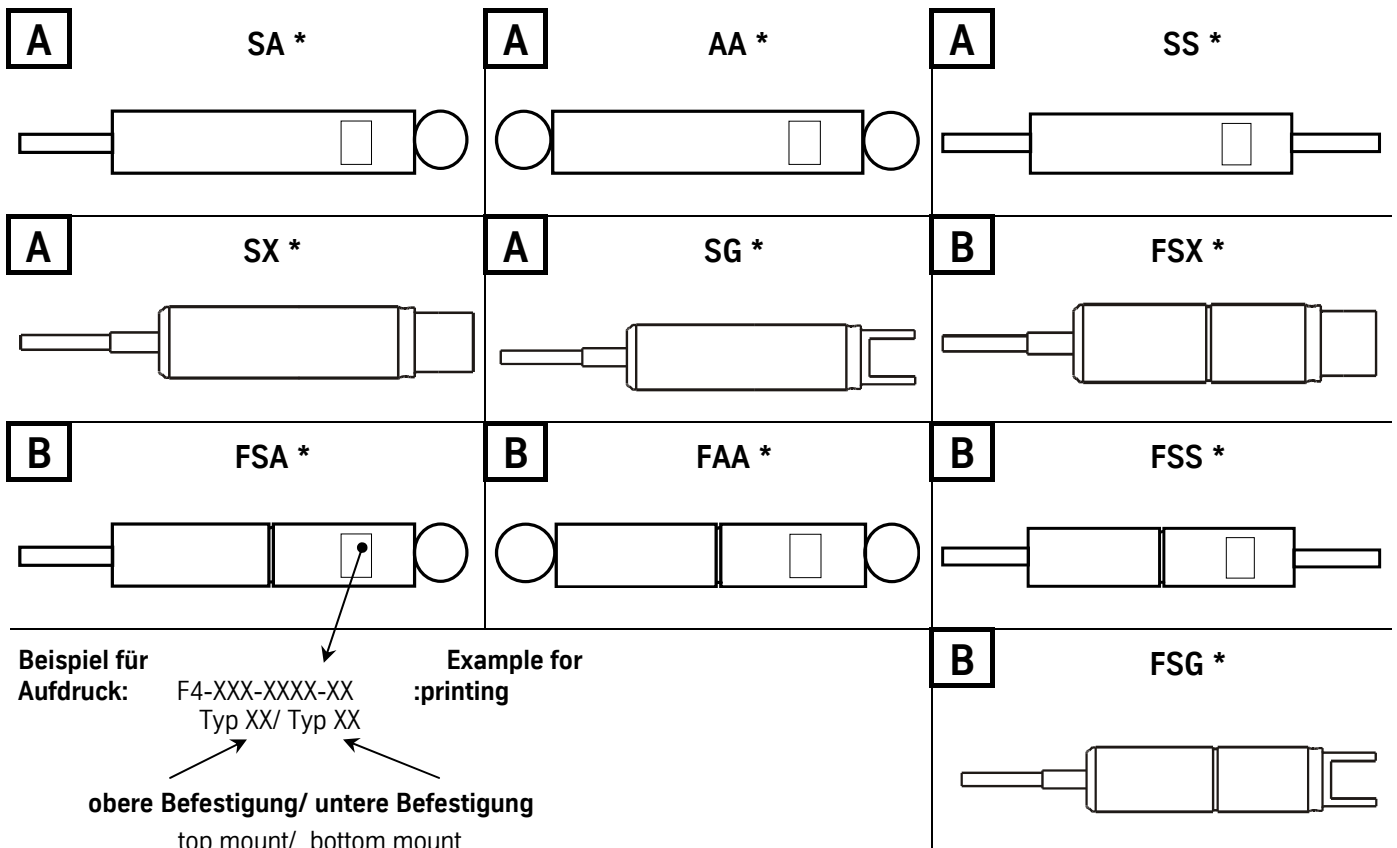

Ist im Lieferumfang kein BILSTEIN Schutzrohr enthalten, muss das Original Schutzrohr wiederverwendet, ggf. erneuert werden.

If no dust cover is delivered by BILSTEIN, original dust cover must be reused or replaced.

Beim Aufschlagen einer Kappe (6) darf die Kolbenstange nicht beschädigt werden!

Do not damage the piston rod when knocking a top cap (6)!

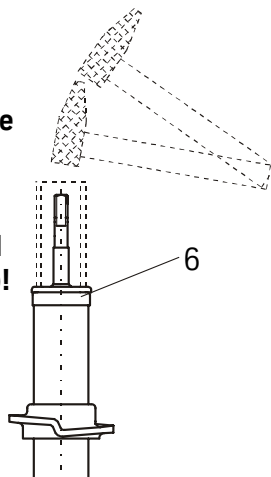

Bei der Montage des Federtellers (1) ist auf den korrekten Sitz des Sprengringes (2) zu achten!

When fitting the spring plate (1) care must be taken to ensure that the circlip ring (2) is seated correctly!

Montage von Tellern mit Fase/ Ausdrehung (falls vorhanden).

X = Fitting of plates with chamfer (if exist)

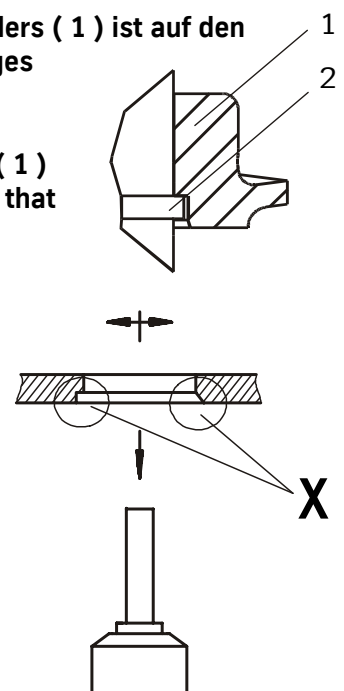

E4-WM5-Y217A00 EINBAUANLEITUNG/ MOUNTING INSTRUCTION



A FEDERTRAGENDE STOSSDÄMPFER

A SPRING CARRIED SHOCK ABSORBER

(FSA *, FAA *, FSS *, FSX *)

1. BILSTEIN- Stossdämpfer mit Original- Feder
2. BILSTEIN- Stossdämpfer mit BILSTEIN- Feder
3. Original- Stossdämpfer mit BILSTEIN- Feder

1. BILSTEIN shock absorber with original spring
2. BILSTEIN shock absorber with BILSTEIN spring
3. Original shock absorber with BILSTEIN spring

Ausbau

Remove

Das Fahrzeug auf eine radfreie Hebebühne stellen, anheben und Räder demontieren.

Place vehicle on a chassis hoist, lift it and remove wheels.



Es ist dafür zu sorgen, das die Schräglenker beim Ausbau, stets mit geeigneten Hilfsmitteln abgestützt werden!



The lower control arm must be supported by suitable means!

Die untere Befestigung lösen und entfernen.

Remove bottom mount.

Die obere Befestigungsmutter am Stützlager entfernen. Nicht die Kolbenstangen- Mutter lösen!

Remove top fixing nuts from support bearing. Do not remove centre nut at this time!

Den Stoßdämpfer komplett ausbauen und in einem geeigneten Spannbock spannen.

Remove complete shock absorber and clamp it in an appropriate strut vice.

Die Feder mit einem Spanngerät so weit vorspannen, bis das Stützlager frei ist.

Compress suspension spring until tension on support bearing is released.

Mutter, Original- Anbauteile und Original- Feder demontieren. Hierbei ist zu prüfen, welche Original- Anbauteile durch Bilstein- Anbauteile (Lieferumfang) ersetzt werden.

Release nut and remove original (mounting parts) just as original spring. Please check, which original mounting parts will be renewed with mounting parts supplied by BILSTEIN.

Einbau

Fitting

BILSTEIN und/ oder Original- Anbauteile, sowie die neue BILSTEIN- Feder in umgekehrter Reihenfolge, analog zum Ausbau, auf das Vorderachsbein montieren.

Fit BILSTEIN and/ or original mounting parts just as the new BILSTEIN spring on the strut in reverse sequence of removal.



Vor dem Entspannen der Feder ist darauf zu achten, das die Federenden korrekt in den Ausschnitten des oberen und unteren Federtellers anliegen!



Before releasing the spring, care is to be taken to ensure that the ends of the spring rest in the cut outs of the top and bottom spring plates.

Die Einbaulage der Federn ist an der Bedruckung ablesbar. Die Federbezeichnung muss in Einbaulage lesbar sein.

The mounting position of the suspension springs can be read by the imprint- have them installed just the way you read the imprint.

Komplettierten Stoßdämpfer in umgekehrter Reihenfolge, analog zum Ausbau, wieder montieren. Um die richtige Montage der Anbauteile zu gewährleisten, ist es notwendig, die auf dem Dämpfer aufgedruckte Typ- Nr. (s. Beispiel) mit den Schaubildern der folgenden Seiten zu vergleichen.

Fit assembled shock absorber to the vehicle in reverse sequence of removal. For to guarantee correct fitting of mounting parts, it is necessary to compare the Type- No, printed on damper-label with the charts on the following pages.

Alle selbstsichernden Muttern werden durch neue ersetzt. Die Anzugsmomente entnehmen Sie der Tabelle Seite 3.

All self- locking nuts must be replaced. Tightening torques see list on page 3.

E4-WM5-Y217A00 EINBAUANLEITUNG/ MOUNTING INSTRUCTION



B STANDARD STOSSDÄMPFER

B STANDARD SHOCK-ABSORBER

(SA *, AA *, SS *, SX *)

1. BILSTEIN- Stossdämpfer mit Original- Feder
2. BILSTEIN- Stossdämpfer mit BILSTEIN- Feder
3. Original- Stossdämpfer mit BILSTEIN- Feder

1. BILSTEIN shock absorber with original spring
2. BILSTEIN shock absorber with BILSTEIN spring
3. Original shock absorber with BILSTEIN spring

Ausbau

Fahrzeug auf radfreie Hebebühne stellen, anheben und Räder demontieren.

Untere Befestigung lösen und entfernen.



Es ist dafür zu sorgen, das die Schräglenker beim Ausbau, stets mit geeigneten Hilfsmitteln abgestützt werden!



Obere Befestigung lösen und entfernen.

Anschließend den Stoßdämpfer ausbauen.

Original Anbauteile demontieren.

Einbau

BILSTEIN und/ oder Original- Anbauteile, analog zum Ausbau, auf BILSTEIN- Stossdämpfer montieren.

BILSTEIN- Stoßdämpfer in umgekehrter Reihenfolge, analog zum Ausbau, montieren. Um die richtige Montage der Anbauteile zu gewährleisten, ist es notwendig, die auf dem Dämpfer aufgedruckte Typ- Nr. (s. Beispiel) mit den Schaubildern der folgenden Seiten zu vergleichen.

Alle selbstsichernden Muttern werden durch neue ersetzt. Die Anzugsmomente entnehmen Sie der folgenden Tabelle.

Tabelle Anzugsmomente **list of torques**

Gewinde	M8	M 10	M 12	M 14	M 16	Thread
Anzugsmoment Nm	13	25	45	72	110	Torque Nm
	10	19	34	54	83	Torque ft lb

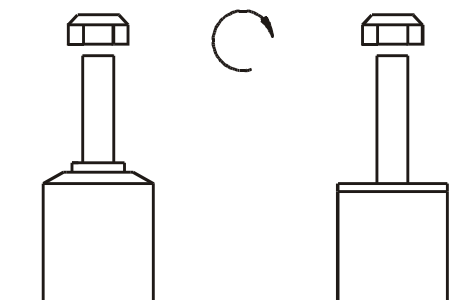

Removal

Place vehicle on a chassis hoist, lift it and remove wheels.

Remove bottom mount.

The lower control arm must be supported by suitable means!

Remove top fixing mount.

Remove shock absorber from vehicle.

Remove original mounting parts.



Installing

Fit BILSTEIN and/ or original mounting parts on shock absorber in reverse sequence of removal.

Fit assembled shock absorber to the vehicle in reverse sequence of removal. For to guarantee correct fitting of mounting parts, it is necessary to compare the Type- No, printed on damper- label with the charts on the following pages.

All self- locking nuts must be replaced. Tightening torques see list below.

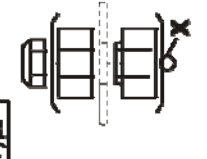
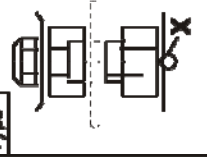
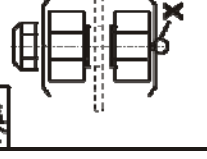
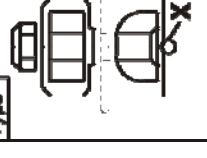
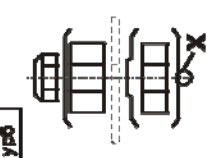
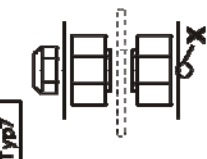
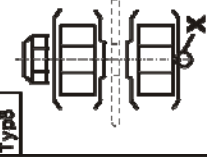
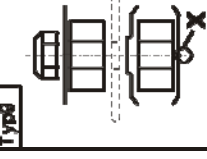
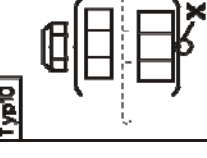
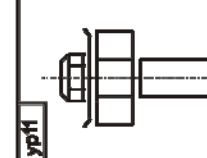
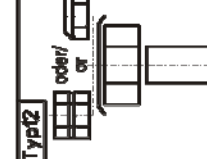
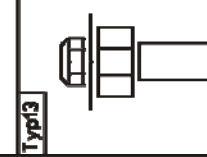
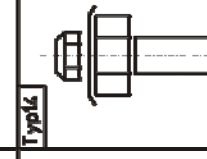
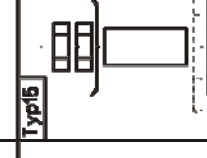
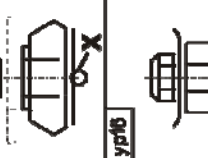
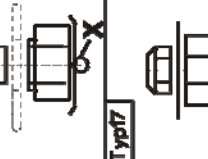
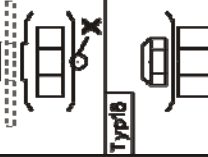
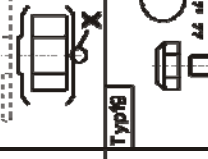
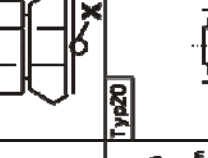
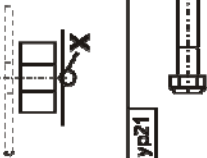
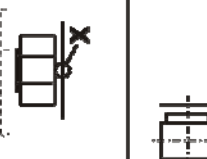
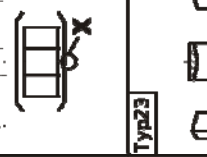
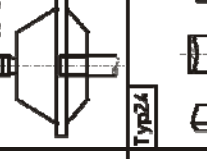
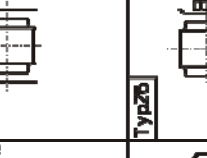
ThyssenKrupp Bilstein Tuning GmbH
Milsper Straße 214, D-58256 Ennepetal
Postfach 1151, D-58240 Ennepetal
Tel. +49(0)2333 791-4444
Fax +49(0)2333 791-4400
info@bilstein.de, www.bilstein.de

Typ1 OE Original Equipment - Original Equipment Original mounting parts	Typ2	Typ3	Typ4	Typ5	Typ6	Typ7	Typ8	Typ9	Typ10	Typ11	Typ12 or/ or	Typ13	Typ14	Typ15	Typ16	Typ17	Typ18	Typ19 44 44 Nm 33 33 lbf	Typ20	Typ21	Typ22	Typ23	Typ24	Typ25	Typ26	
																										
Typ27	Typ28	Typ29	Typ30	Typ31	Typ32	Typ33	Typ34	Typ35	Typ36	Typ37	Typ38	Typ39	Typ40	Typ41	Typ42	Typ43	Typ44	Typ45	Typ46	Typ47	Typ48	Typ49	Typ50	Typ51	Typ52	Typ53
