



INSTALLATION INSTRUCTIONS

REAR DISC BRAKE CONVERSION KITS A112, A112-1 & A112-93

1979-93 FORD MUSTANG with 7.5" & 8.8" AXLES

Thank you for choosing STAINLESS STEEL BRAKES CORPORATION for your braking needs. Please take the time to read and carefully follow these instructions to insure the ease of your installation as well as the proper performance of the complete system.

Before beginning your installation, please verify you have received all the parts indicated on the packing slip. If you believe anything to be missing or incorrect, please call our Customer Service Department at 716-759-8669.

To assure your installation will go safely and smoothly, have the following items on hand to assist you:

JACK & JACK STANDS
LUG WRENCH
TORQUE WRENCH
SOCKET SET
BRAKE CLEANER

WRENCH SET
TUBE WRENCHES
MALLET
GEAR OIL
BRAKE FLUID

These kits use the following pads:

SSBC#: 1047
FMSI#: D-347

Revised to level 3 2/28/12

TIP: BEFORE BEGINNING INSTALLATION, SPRAY ALL FITTINGS & FASTENERS WITH PENETRATING OIL.

1. Drum Brake Removal

- a) Raise the car until the tires and wheels clear the floor and support the car on jack stands. Remove the tires and wheel assemblies from the drum.
- b) Pull the brake drums off the axle shafts . If the brake drum will not come off easily, retract the shoes by inserting a narrow screwdriver through the adjusting slot in the backing plate and back off the adjusting screw.
- c) Remove the brake shoes and all the hardware.
- d) Disconnect parking brake cable from the actuator and pull through the backing plate after compressing the retaining clip.
- e) Disconnect the rigid brake line from the back of the wheel cylinder. Always use a tube wrench on brake lines so not to strip the tube nut.

2. Removal of the Axles & Backing Plates

- a) Remove differential cover and drain all fluid into a drain pan.
- b) Working through the open case, remove the pinion shaft lock bolt. (7mm hex)
- c) Push pinion lock shaft out of the rear end housing.
- d) Push the axle shafts inward and remove the “C” locks from the ends of the axle shafts.
- e) Carefully pull the axle shafts out of the rear end being careful not to damage the axle bearings or seals.
- f) Remove the four nuts and bolts that secure the backing plates to the rear end housing and remove and discard the backing plates. **Photo 1**

3. Installation of Caliper Mounting Brackets

- a) Caliper brackets are marked “Left” and “Right”. Be sure to install them on the correct sides.
- b) Install the brackets so the calipers will point towards the rear of the car. The stepped part of the bracket should step in towards the center of the car. **See Assembly Drawing.**
- c) Secure the brackets to the axles using the 3/8”-24 x 1-1/4” bolts and nuts supplied with the kit.

4. Installation of Axles Shafts and Rotors



CAUTION: Prior to reinstalling axle shaft, measure the diameter of the axle flange. Occasionally, semi-finished axles with oversize outer flange diameters are installed in cars; this can prevent proper seating of the rotors which in turn may cause damage and excessive run-out. The diameter must not be greater than 5.82” (alternate measurement: flange circumference = 18-1/4”). In the unusual event that this diameter is greater than 5.82” the axle diameter will require machining before proceeding.

- a) Reinstall the axle shafts, C-locks, lock pin and lock bolt in the reverse of removal.



BE SURE TO INSTALL A NEW DIFFERENTIAL GASKET AND REFILL THE REAR END WITH THE PROPER GEAR OIL TO THE PROPER LEVEL.

- b) Clean the rotors thoroughly with brake cleaner to remove the protective packing coating.
- c) Slide the rotors into position on the ends of the axle shafts and secure them with at least one lug nut.

5. Caliper Installation

- a) The calipers are marked “Left” and “Right”. Be sure to install them on the correct side.
- b) Place caliper over the rotor and secure it to the mounting brake using the 12mm bolts supplied. Torque the bolts to 80-100 ft / lbs. The bleeder screws should be pointing up and the parking brake levers will point down. **Photo 3**

6. Inlet Tube and Support Clip

- a) Attach brass “banjo” fitting with special hollow bolt and two (2) copper washers. Be sure to install a copper washer on each side of the brass block. Tighten to 20-30 ft/lbs.
- b) Attach rigid caliper inlet line to brass fitting and secure to axle with sheet metal clip and screw. Use existing hole, clip and screw that secured original brake tube to axle housing. Attach brass union to line. **Photo 4**
- c) Connect original axle brake line to brass union. Be sure to use tube wrenches. You will need to hand bend original line so that it will reach caliper line neatly. Be sure not to kink the line. Use a tube bender. **Photo 4**

7. Parking Brake Cables

- a) Remove old parking brake cables.
- b) Install new cables (provided in kit) in the same manner as original cables. Make sure that housing “snap clips” are toward the front of the car. Route cables through floor pan gussets and assure that clips are securely seated (snapped) in floor pan holes, as in original installation.
- c) Route cable over guide grooves and then to parking brake lever (under console) as in original installation at one end and to caliper parking brake lever at the other end.
- d) Attach parking brake cables to caliper parking brake levers:
 - 1) Push cable housings through holes in cast loop of each caliper and secure with “e” rings supplied.
 - 2) Engage ends of cables into slots of caliper parking brake levers.

8. Master Cylinder



NOTE: Mustangs, model years 1987 and later, are delivered with master cylinders having a smaller output capacity and metric fittings. When converting to rear discs, a larger master cylinder must be installed to prevent a “spongy” brake pedal condition. To prevent this, a larger capacity cylinder has been provided in the A112-1 kit. Since this master cylinder has SAS ports, a line adapter kit has also been included.

Installation is as shown in Photo #5.

Follow instructions for 1987 and later cars as follows:

- 1) Remove three brake lines from the existing master cylinder. Note that one line is on the bottom of the unit.
- 2) Remove the mater cylinder from the booster, save lock nuts, discard original master cylinder. Make sure that no brake fluid is allowed to contact paint.
- 3) Remove two existing brake lines from distribution block, discard lines. Use a six point tube wrench.
- 4) Connect adapter TEE (provided) to third brake tube. This is the tube which was originally connected to the bottom of the master cylinder. Do not tighten fittings at this point.



NOTE: Master cylinder must be bench bled prior to installation.

- 5) Install new master cylinder (0406*) on booster and secure with original lock nuts. (Installation is tight but will fit).
- 6) Install "short elbow tube" from adapter TEE (female nut) to larger port of the new master cylinder (male nut).
- 7) Install line from distribution block to adapter TEE.
- 8) Install line from distribution block to smaller port of the master cylinder.
- 9) Securely tighten all fittings before filling and bleeding hydraulic system.



BE SURE TO CHECK FOR LEAKS AT ALL CONNECTIONS WITH THE PEDAL APPLIED, FOR MAXIMUM LINE PRESSURE, BEFORE DRIVING VEHICLE!

- 10) For all model year master cylinders: After installation is complete, the pedal height and firmness may be adjusted for "best feel" by slightly shortening or lengthening the booster output push-rod (one or two turns maximum). This adjustment can be made without breaking the hydraulic lines. However, care must be taken that brakes release properly when pedal is released. A dragging or locked-up brake is the result of an over length push rod.

9. Distribution Block and Proportioning Valve

- a) Unscrew plug from front side of distribution block. BE CAREFUL - it is spring loaded. Inside the unit is a spring, spring seat and piston *Illustration #1*. Pull out spring and piston (use needle nose pliers). Remove U-cup and spring from piston and discard.
- b) Reassemble using only the bare piston. Screw plug back into block. BE SURE TO LEAVE OUT SPRING AND U-CUP SEAL, BUT SEAL UNDER PLUG MUST REMAIN.
- c) If desired, an adjustable "in-line" proportioning valve is available from SSBC as an extra cost option. *Refer to Photo #6*.



NOTE: BE CAREFUL THAT ALL HYDRAULIC COMPONENTS ARE KEPT CLEAN AND FREE OF DEBRIS INSIDE AND OUT. REMEMBER, DIRT IS THE ENEMY OF HYDRAULIC SYSTEMS AND WE WILL NOT BE RESPONSIBLE FOR SYSTEM FAILURES DUE TO UNCLEAR INSTALLATIONS!

10. Filling and Bleeding system

- a) It is advisable to replace the brake fluid if the color is brown or muddy. This is due to water that has been absorbed by the fluid which will eventually corrode the brake lines and master cylinder. This absorbed moisture can also cause a vapor lock situation under extreme braking conditions. Flush system with clean brake fluid and replace with a good grade of disc brake fluid. DOT 3 or DOT 4 fluids are acceptable.
- b) The simplest and most effective way to bleed your brakes is to use the gravity bleeding approach as follows:
 - 1) With calipers installed, make sure all fittings are tight and master cylinder is topped off.
 - 2) Open one bleeder screw at a time starting at the wheel farthest from the master cylinder and working your way back around the wheel closest to the master. With bleeder screw open, observe bleeder. At first the fluid will begin to escape with intermittent air bubbles. When the air bubbles stop and a steady flow of fluid is observed for several seconds, close the bleeder valve and move on to the next wheel.



MAKE SURE TO KEEP A CLOSE WATCH OVER THE FLUID LEVEL INSIDE THE MASTER CYLINDER DURING THE BLEEDING PROCESS. NEVER LET THE RESERVOIR RUN DRY. ALWAYS KEEP IT AT LEAST 1/3 FULL.

- 3) After bleeding all four wheels and topping of the master cylinder make 20-30 applications of the brake pedal. If a hard pedal is experienced, no further bleeding is required. If pedal is spongy, repeat bleeding process until a hard pedal is achieved.
- 4) With all bleeding complete, there should be approximately 3/4" to 1" of end play.
- 5) Power brake cars will experience a "drop off" of the pedal when the engine is started. This is a normal condition that signifies the booster is working.
- 6) Pedal end play can be adjusted under the dash on non power cars and between the booster and master on power brake cars.

11. Parking Brake Adjustment

- a) Advance pistons of calipers so that clearance between pads and rotors is 1/32-1/16". Piston should be advanced using hydraulic system instead of parking brake levers. About 40 pumps of the pedal are required to extend the pistons to the correct clearance.



IF PISTON HAS BEEN EXTENDED TOO FAR, TURN PISTON BACK INTO CALIPER. IF DESIRED, USE SPECIAL TOOL KD-2545 AVAILABLE AT MOST PARTS STORES. A PAIR OF NEEDLE NOSE PLIERS WILL ALSO WORK.

- b) Pull up parking brake handle one click.
- c) Tighten cable at level until lever on caliper just begins to leave the "stop" (both sides.)
- d) Release parking brake handle. There should be no drag.



NOTE: 1987 AND LATER MUSTANGS INCORPORATE A SELF ADJUSTING PARKING BRAKE MECHANISM. IF THIS SYSTEM WILL NOT ALLOW ENOUGH ADJUSTMENT ON YOUR CAR FOR PROPER PARKING BRAKE OPERATION, AN ADJUSTABLE CABLE MAY BE PURCHASED FROM SSBC. THERE IS AN EXTRA COST ON THIS PART AND IT CAN BE PURCHASED FROM US OR DIRECTLY FROM FORD MOTORSPORT AS PART NO. M-2810-A.

FINAL INSPECTION

- a) Once a hard pedal is achieved, all fittings and connections must be inspected to make sure there are no leaks. Also check the level in both reservoirs of the master cylinder and top off if needed.
- b) Put wheels back on the car and turn wheel by hand to insure that the wheel spins freely and does not interfere with any brake components.
- c) When you are sure there are no interferences and the pedal is firm, torque the lug nuts and lower the car back onto the ground. Test drive the car and apply the brakes frequently to seat the pads.

NOTE: DO NOT USE ANTI-SQUEAK ADHESIVE ON BACKS OF PADS. THIS WILL DEGRADE THE PERFORMANCE OF THE CALIPER!

DO NOT DRIVE IN TRAFFIC UNTIL THE BRAKES SAFELY STOP THE CAR A SAFE DISTANCE WITHOUT A SPONGY PEDAL FEEL!

BRAKING TESTS SHOULD ALWAYS BE DONE IN A SAFE OPEN AREA!

NOTE: For frequently asked questions and technical reference information please visit the tech section of our website at www.ssbrakes.com.

TECH LINE -- If technical help is required, please call 716-759-8666.

NOW ENJOY TRUE PERFORMANCE BRAKING!!

REPLACEMENT PARTS APPLICATION

The calipers, brake pads and rotors used in this conversion kit are the same as those used from the factory on 1987-88 Ford Thunderbird Turbo Coupe. If you have a problem locating the correct replacement pads, have your parts store reference the FMSI #D347.

A112 A112-1

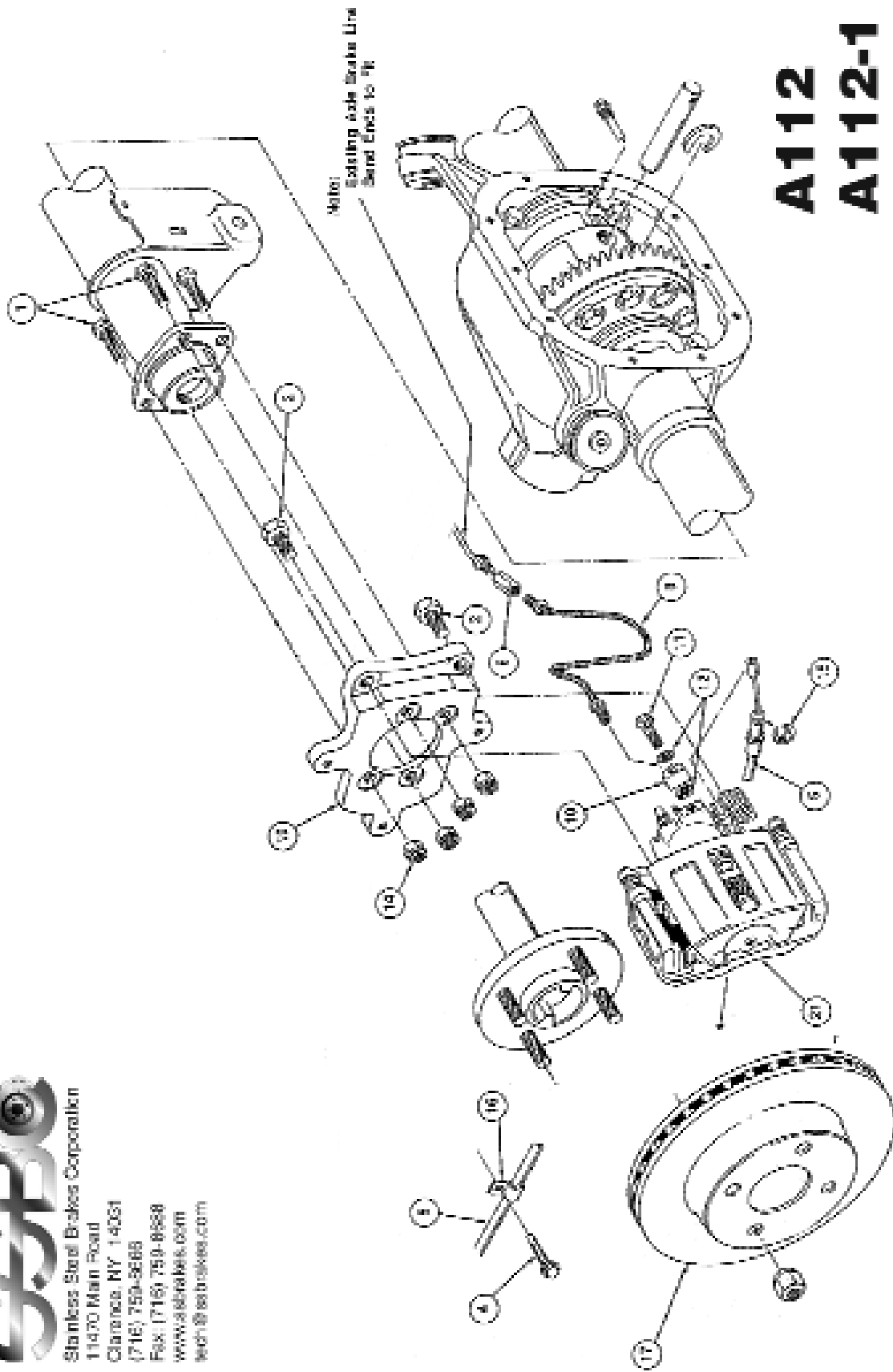

SSB
 Stainless Steel Brakes Corporation
 11470 Main Road
 Clarence, NY 14031
 (716) 759-8688
 Fax: (716) 759-8688
 www.ssbbrakes.com
 tech@ssbrakes.com

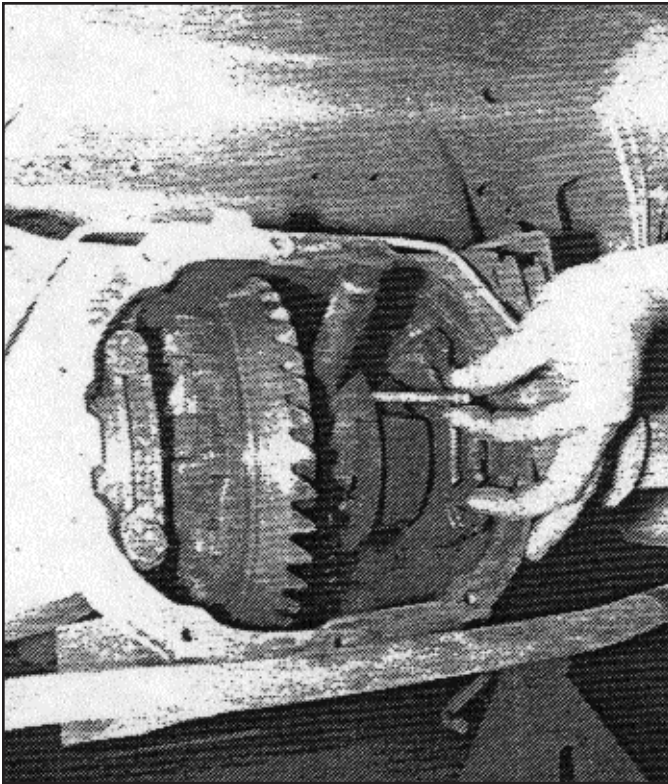

Photo #1

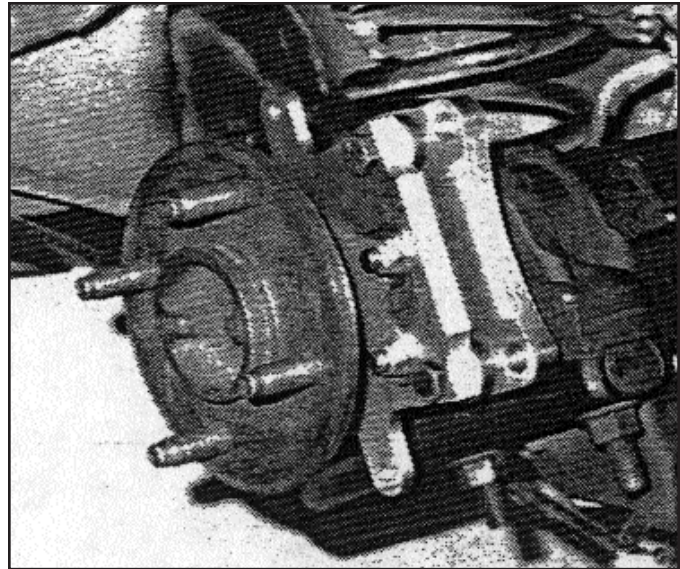

Photo #2
Caliper mounting bracket is now a casting.

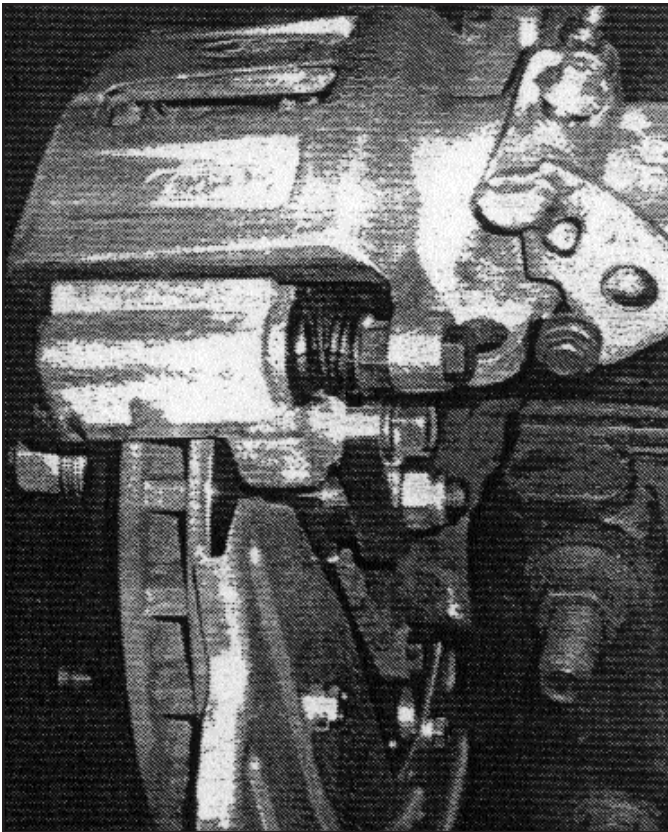

Photo #3

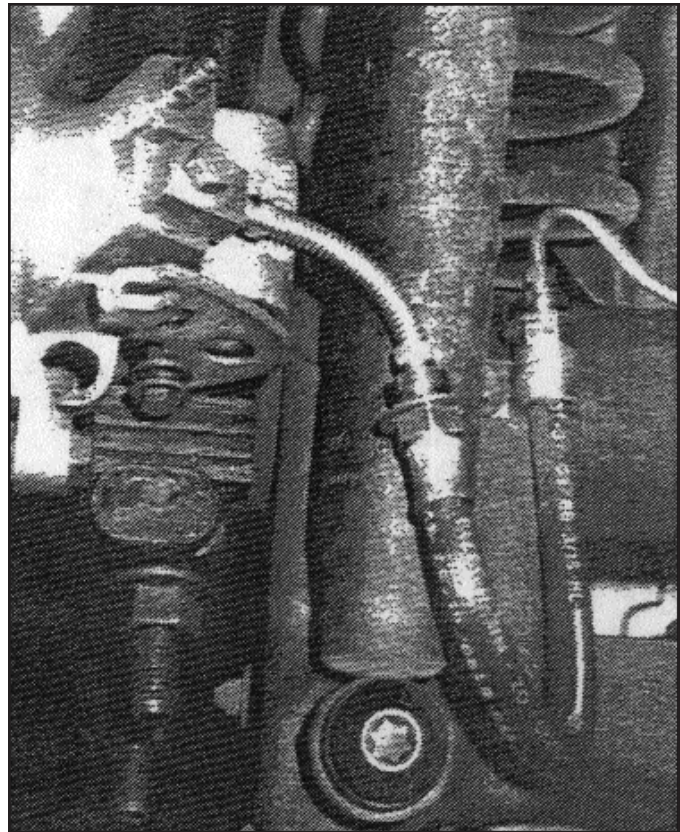

Photo #4
Caliper inlet line is now rigid.

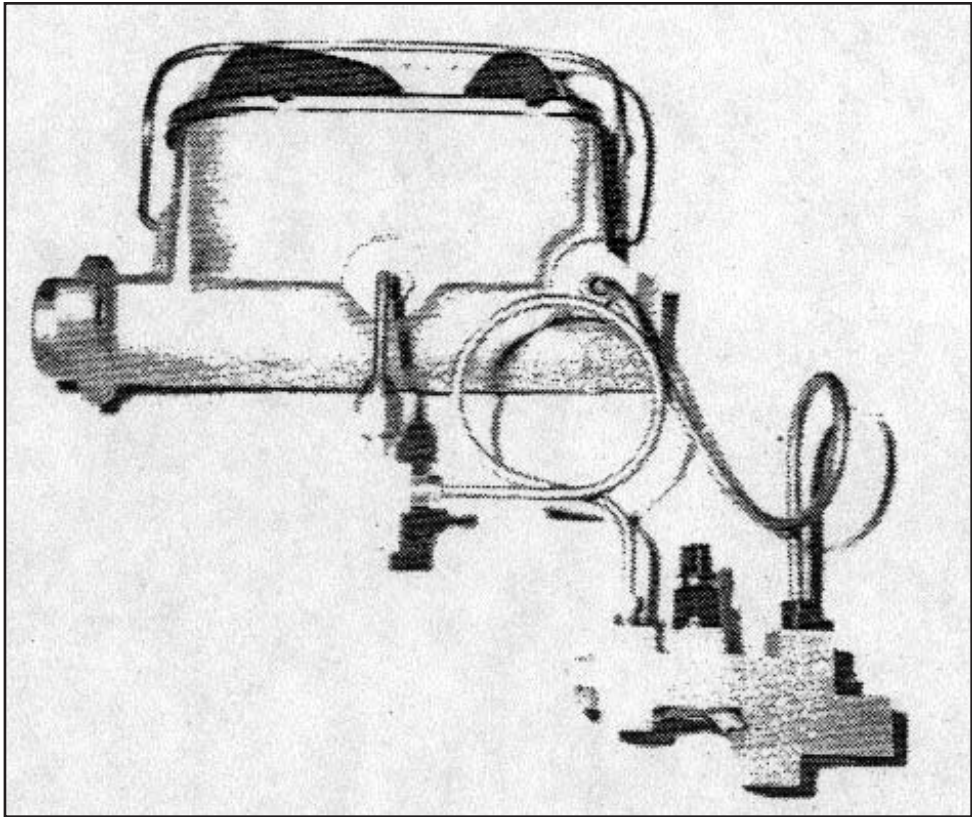

Photo #5

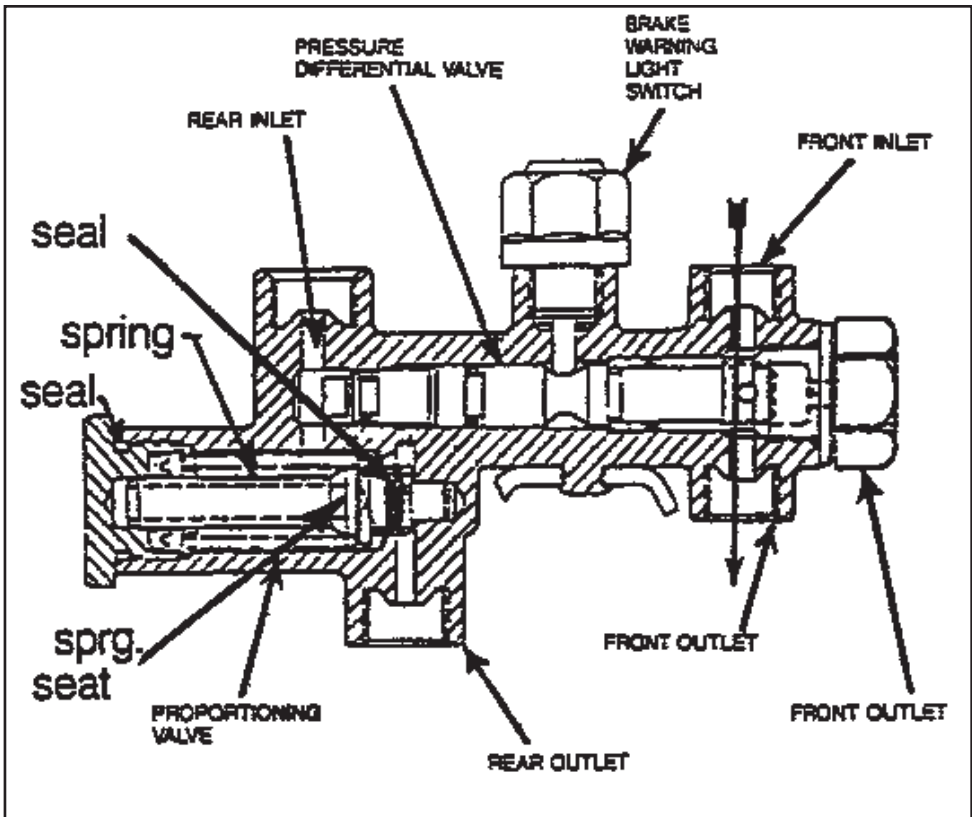
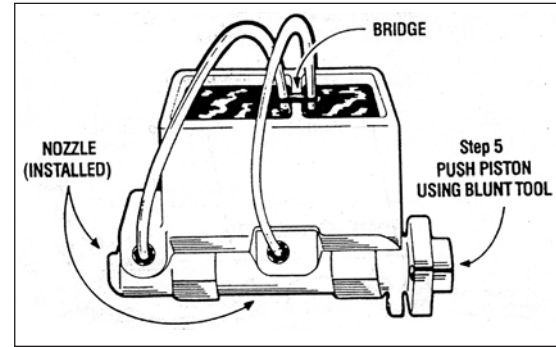

Illustration #1 - Combination Valve

How and why do I bench bleed a master cylinder?

When installing or replacing a master cylinder, it is critical that all air is removed from the master cylinder. This can easily be done by bench bleeding the master cylinder prior to installation. Using the SSBC master cylinder bleeder kit (#0460):

- 1) Place your master cylinder in a vise by the ears (not body). Make sure it is level.
- 2) Attach a piece of clear plastic hose to the short end of one of the plastic nozzles. Do the same to the other hose and nozzle.
- 3) Clip the plastic bridge to the wall and push the ends of the hose through the holes so they are SUBMERGED in the reservoir on either side of the wall.
- 4) Press the tapered end of the nozzle FIRMLY into the cylinder port hole with a twisting motion. Repeat this procedure on the other port hole.
- 5) Fill the reservoir with CLEAN brake fluid recommended by the manufacturer.
- 6) Using full strokes, push the piston in, then release. Do this until ALL the air bubbles have disappeared from the clear plastic hose. **(CAUTION-MASTER CYLINDER WILL NOT BLEED PROPERLY UNLESS HOSES ARE SUBMERGED IN BRAKE FLUID UNTIL THE BLEEDING PROCESS IS COMPLETED.)**



Now mount master cylinder and avoid brake fluid leaking out of front and rear ports during installation.

Bleeding steps for Dual Port Master Cylinder

If you have a master cylinder with dual port holes (4 port holes - 2 on each side), it is necessary to bleed both port sides of the master cylinder. If both sides of the master cylinder are not bled, there will be air trapped in the master cylinder and your brakes will not function properly.

To bleed dual port master cylinders:

- 1) Follow steps 1 - 6 above on the side you will be hooking the brake lines to. Plug the other side.
- 2) Once the air bubbles are no longer visible in the plastic hose, open the bleeder screws in the supplied plugs and allow the mater cylinder to gravity bleed. **DO NOT** push the master cylinder piston in while the plugs are gravity bleeding.
- 3) When clear, steady streams of fluid are coming out of both bleeders, close and tighten the bleeders. Give the master cylinder piston several strokes, making sure there are still no bubbles present in the clear plastic tubes.
- 4) Remove the tubes and plastic fittings and mount the master cylinder on the vehicle being careful not to spill brake fluid on any painted surfaces.

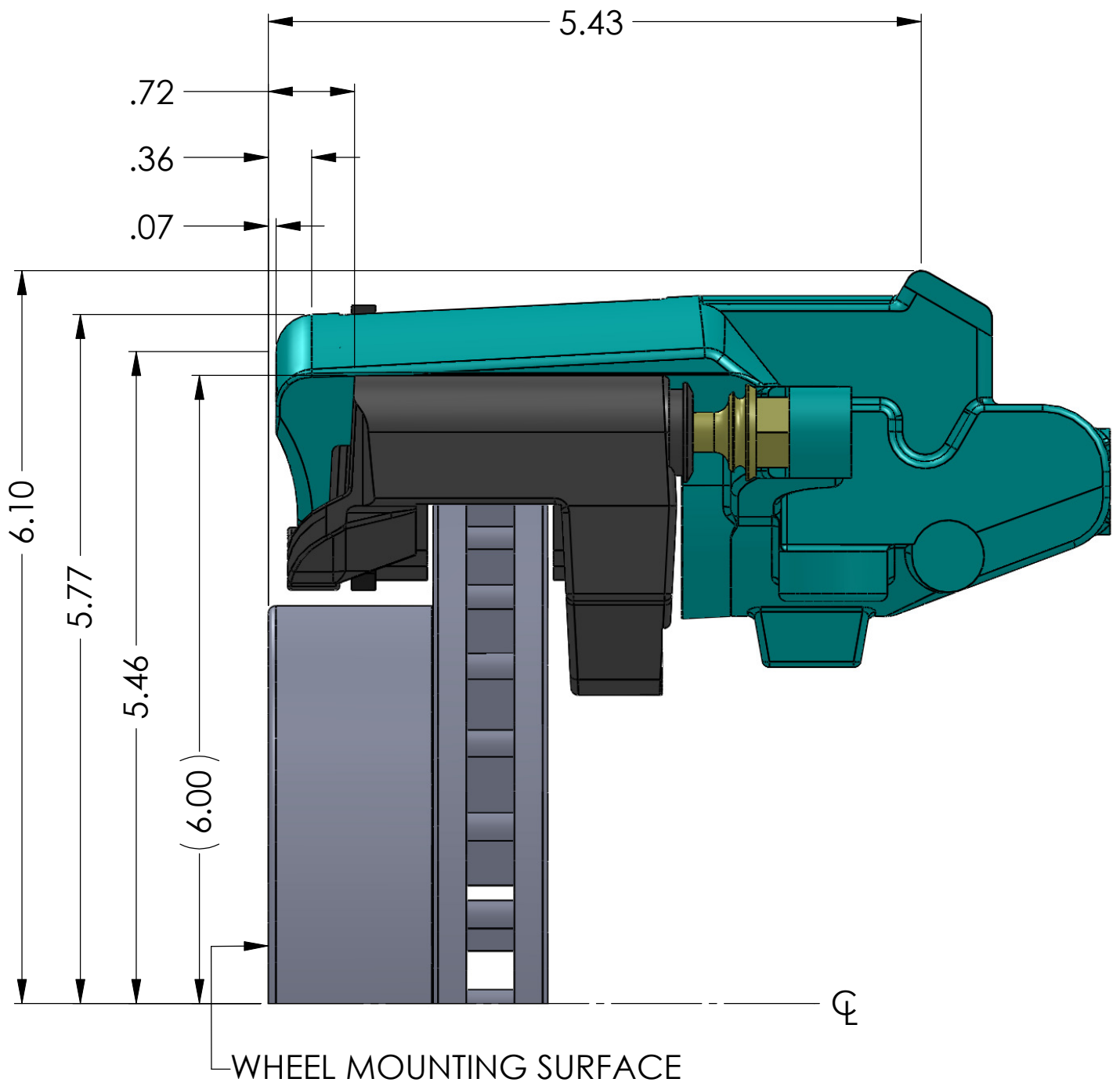

DIMENSIONS ARE IN INCHES

TEMPLATE NO.
T-039

DO NOT SCALE
DRAWING

REV
-

SSBC

STAINLESS STEEL BRAKE CORP.

CLARENCE, NEW YORK 14031-1720
Ph: 716-759-8666 / 800-448-7722 ~ Fx: 716-759-8688
WWW.SSBRAKES.COM